

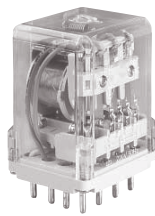









R15 2 C/O



R15 3 C/O



R15 4 C/O

• Relays of general application • For plug-in sockets, 35 mm rail mount acc. to PN-EN 60715 or on panel mounting • Cadmium - free contacts - R15 2 C/O, R15 3 C/O relays • WT (mechanical indicator + lockable front test button) - standard features of R15 2 C/O, R15 3 C/O relays in cover, for plug-in sockets. Relays may be provided with the test buttons (no latching) and plugs - page 251 • **Have obtained LR Type Approval Certificate (Lloyd's Register) - R15...WT 2 C/O, R15...WT 3 C/O** • Recognitions, certifications, directives: RoHS, AUCOTEAM GmbH Berlin - railway standards,       

Contact data

Number and type of contacts	2 C/O, 3 C/O, 4 C/O	
Contact material	2 C/O, 3 C/O: AgNi , AgNi/Au 0,2 µm, AgNi/Au 5 µm 4 C/O: AgCdO , AgCdO/Au 0,2 µm, AgCdO/Au 5 µm	
Rated / max. switching voltage	AC	2 C/O, 3 C/O: 250 V / 440 V 4 C/O: 250 V / 250 V
Min. switching voltage	2 C/O, 3 C/O: 5 V AgNi, 5 V AgNi/Au 0,2 µm, 5 V AgNi/Au 5 µm 4 C/O: 10 V AgCdO, 10 V AgCdO/Au 0,2 µm, 5 V AgCdO/Au 5 µm	
Rated load (capacity)	AC1	10 A / 250 V AC 10 A / 277 V AC UL 508
	AC15	3 A / 120 V 1,5 A / 240 V (B300)
	AC3	370 W (single-phase motor, 1/2 HP / 240 V AC UL 508)
	DC1	10 A / 24 V DC (see Fig. 3)
	DC13	0,22 A / 120 V 0,1 A / 250 V (R300)
Min. switching current	2 C/O, 3 C/O: 5 mA AgNi, 5 mA AgNi/Au 0,2 µm, 2 mA AgNi/Au 5 µm 4 C/O: 10 mA AgCdO, 10 mA AgCdO/Au 0,2 µm, 2 mA AgCdO/Au 5 µm	
Max. inrush current	20 A	
Rated current	10 A	
Max. breaking capacity	AC1	2 500 VA
Min. breaking capacity	2 C/O, 3 C/O: 0,3 W AgNi, 0,3 W AgNi/Au 0,2 µm, 0,05 W AgNi/Au 5 µm 4 C/O: 0,5 W AgCdO, 0,5 W AgCdO/Au 0,2 µm, 0,05 W AgCdO/Au 5 µm	
Contact resistance	≤ 100 mΩ	
Max. operating frequency		
• at rated load	AC1	1 200 cycles/hour
• no load		12 000 cycles/hour

Coil data

Rated voltage	AC	2 C/O, 3 C/O: 6 ... 240 V 50/60 Hz 4 C/O: 6 ... 240 V 50 Hz, 60 Hz
	DC	6 ... 220 V
Must release voltage	AC: ≥ 0,15 U _n DC: ≥ 0,1 U _n	
Operating range of supply voltage	see Tables 1, 2, 3, 4	
Rated power consumption	AC: 2,8 VA 50 Hz 2,5 VA 60 Hz DC: 1,5 W	

Insulation according to PN-EN 60664-1

Insulation rated voltage	250 V AC	
Rated surge voltage	2 500 V 1,2 / 50 µs	
Overvoltage category	III	
Insulation pollution degree	3	
Dielectric strength	• between coil and contacts	2 500 V AC type of insulation: basic
	• contact clearance	1 500 V AC type of clearance: micro-disconnection
	• pole - pole	2 000 V AC type of insulation: basic
Contact - coil distance		
• clearance	2 C/O, 3 C/O, 4 C/O: ≥ 3 mm	
• creepage	2 C/O, 3 C/O: ≥ 4,2 mm	4 C/O: ≥ 3,2 mm

General data

Operating / release time (typical values)	AC: 12 ms / 10 ms DC: 18 ms / 7 ms	
Electrical life	• resistive AC1	≥ 2 x 10 ⁵ 10 A, 250 V AC
	• cosφ	see Fig. 2
Mechanical life (cycles)	≥ 2 x 10 ⁷	
Dimensions (L x W x H)	2 C/O, 3 C/O: 35 x 35 x 54,4 mm	4 C/O: 35 x 42,5 x 54,5 mm
Weight	2 C/O, 3 C/O: 83 g	4 C/O: 95 g
Ambient temperature	• storage	-40...+85 °C
	• operating	AC: -40...+55 °C DC: -40...+70 °C
Cover protection category	IP 40	PN-EN 60529
Environmental protection	RTI	PN-EN 116000-3
Shock resistance	10 g	
Vibration resistance	5 g 10...150 Hz	
Solder bath temperature	max. 270 °C	
Soldering time	max. 5 s	

The data in bold type pertain to the standard versions of the relays.

Coil data - DC voltage version

Table 1

Coil code	Rated voltage U_n V DC	Coil resistance $\pm 10\%$ at 20 °C Ω	Coil operating range V DC	
			min. (at 20 °C)	max. (at 55 °C)
1006	6	28	4,8	6,6
1012	12	110	9,6	13,2
1024	24	430	19,2	26,4
1048	48	1 750	38,4	52,8
1060	60	2 700	48,0	66,0
1110	110	9 200	88,0	121,0
1120	120	11 000	96,0	132,0
1220	220	37 000	176,0	242,0

The data in bold type pertain to the standard versions of the relays.

Coil data - AC 50/60 Hz voltage version (standard for R15 2 C/O, R15 3 C/O)

Table 2

Coil code	Rated voltage U_n V AC	Coil resistance $\pm 15\%$ at 20 °C Ω	Coil operating range V AC	
			min. (at 20 °C)	max. (at 55 °C)
5006	6	4,3	4,8	6,6
5012	12	18,5	9,6	13,2
5024	24	75,0	19,2	26,4
5048	48	305,0	38,4	52,8
5060	60	475,0	48,0	66,0
5115	115	1 840,0	92,0	126,5
5120	120	1 910,0	96,0	132,0
5220	220	6 980,0	176,0	242,0
5230	230	7 080,0	184,0	253,0
5240	240	7 760,0	192,0	264,0

The data in bold type pertain to the standard versions of the relays.

Coil data - AC 50 Hz voltage version (standard for R15 4 C/O)

Table 3

Coil code	Rated voltage U_n V AC	Coil resistance $\pm 15\%$ at 20 °C Ω	Coil operating range V AC	
			min. (at 20 °C)	max. (at 55 °C)
3006	6	4,8	4,8	6,6
3012	12	20,0	9,6	13,2
3024	24	72,0	19,2	26,4
3048	48	360,0	38,4	52,8
3060	60	520,0	48,0	66,0
3115	115	2 100,0	92,0	126,5
3120	120	2 300,0	96,0	132,0
3220	220	7 000,0	176,0	242,0
3230	230	7 900,0	184,0	253,0
3240	240	8 300,0	192,0	264,0

Coil data - AC 60 Hz voltage version (special for R15 4 C/O)

Table 4

Coil code	Rated voltage U_n V AC	Coil resistance $\pm 15\%$ at 20 °C Ω	Coil operating range V AC	
			min. (at 20 °C)	max. (at 55 °C)
6006	6	4,8	4,8	6,6
6012	12	17,0	9,6	13,2
6024	24	65,0	19,2	26,4
6048	48	310,0	38,4	52,8
6060	60	490,0	48,0	66,0
6110	110	1 760,0	88,0	121,0
6120	120	2 000,0	96,0	132,0
6220	220	6 900,0	176,0	242,0
6230	230	7 000,0	184,0	253,0
6240	240	7 100,0	192,0	264,0

Mounting

Relays R15 2 C/O and R15 3 C/O are offered in version: • standard WT (mechanical indicator + lockable front test button), for plug-in sockets. **In standard version of relays (WT) is possibility self-exchange of button type T for test button R15-M404 (no latching) or plug R15-M203 (no manual operation). Test buttons (no latching) and plugs need to ordered separately.**

Relays **R15 2 C/O** are designed for: • screw terminals plug-in sockets **PZ8** with clip **PZ11 0031**, 35 mm rail mount acc. to PN-EN 60715 or on panel mounting with two M3 screws • screw terminals plug-in sockets **GZU8** with clip **GZU 1052**, 35 mm rail mount acc. to PN-EN 60715 • screw terminals plug-in sockets **GZ8** with clip **GZ 1050**, on panel mounting with two M3 screws • screw terminals plug-in sockets **GZS8**, 35 mm rail mount acc. to PN-EN 60715 or on panel mounting with two M3 screws • screw terminals plug-in sockets **GZP8** with clip **GZP-0054**, 35 mm rail mount acc. to PN-EN 60715 or on panel mounting with two M3 screws • solder terminals sockets **GOP8** with clip **R159 1051** and spring clamp **R15 5922** • direct PCB mounting.

Relays **R15 3 C/O** are designed for: • screw terminals plug-in sockets **PS11** and **PZ11** with clip **PZ11 0031**, 35 mm rail mount acc. to PN-EN 60715 or on panel mounting with two M3 screws • screw terminals plug-in sockets **GZU11** with clip **GZU 1052**, 35 mm rail mount acc. to PN-EN 60715 • screw terminals plug-in sockets **GZ11** with clip **GZ 1050**, on panel mounting with two M3 screws • screw terminals plug-in sockets **GZS11**, 35 mm rail mount acc. to PN-EN 60715 or on panel mounting with two M3 screws • screw terminals plug-in sockets **GZP11** with clip **GZP-0054**, 35 mm rail mount acc. to PN-EN 60715 or on panel mounting with two M3 screws • solder terminals sockets **GOP11** with clip **R159 1051** and spring clamp **R15 5922** • direct PCB mounting.

Relays R15 4 C/O are offered in version • in cover, for plug-in sockets.

Relays **R15 4 C/O** are designed for: • screw terminals plug-in sockets **GZ14U** with clip **GZ14 0737**, 35 mm rail mount acc. to PN-EN 60715 • screw terminals plug-in sockets **GZ14** with clip **GZ14 0737**, on panel mounting with two M3 screws • screw terminals plug-in sockets **GZ14Z** with clip **GZ14 0737**, on panel mounting with two M3 screws • solder terminals sockets **GOP14** with clip **R15 0736** and spring clamp **R15 5922**.

NEW product 

GZ14Z

Screw terminals plug-in socket for R15 4 C/O **to be mounted behind the assembly panel** - see page 248.

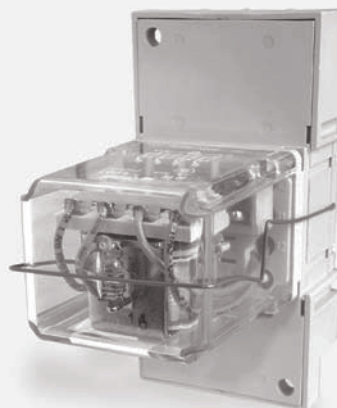

Electrical life at AC resistive load.
Switching frequency: 1 200 cycles/hour

Fig. 1

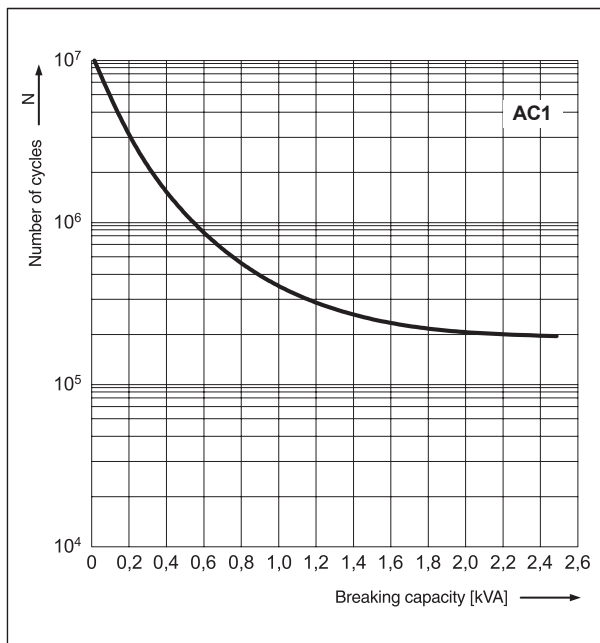

Electrical life reduction factor at AC inductive load

Fig. 2

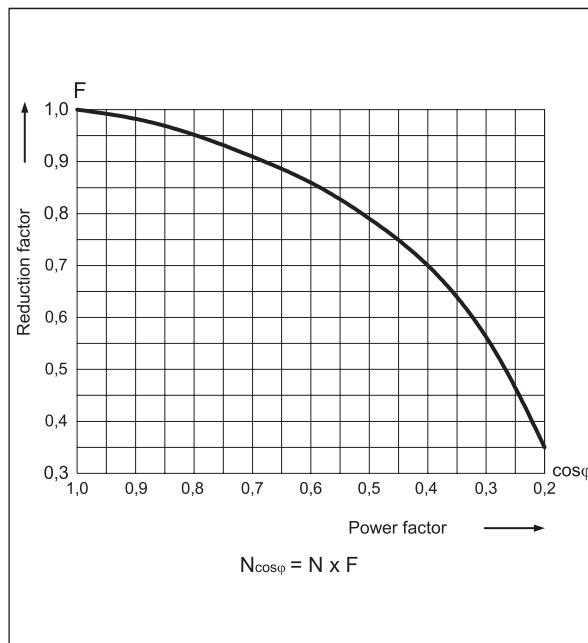

Max. DC breaking capacity
A - resistive load DC1
B - inductive load L/R = 40 ms

Fig. 3

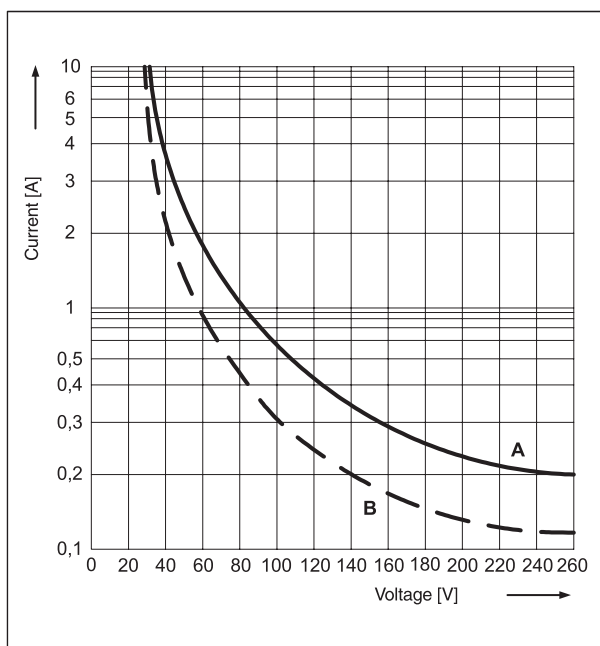

R15 4 C/O in cover, for plug-in sockets

• Recognitions, certifications, directives: RoHS,     

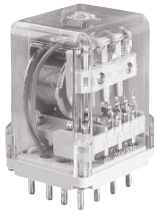

R15 4 C/O

Dimensions

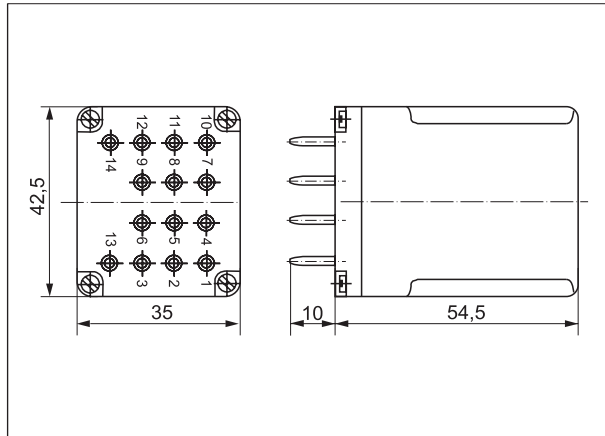

Connection diagram (pin side view)

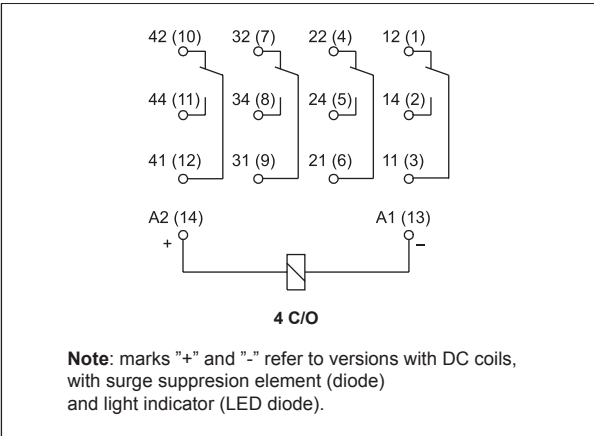

Ordering codes

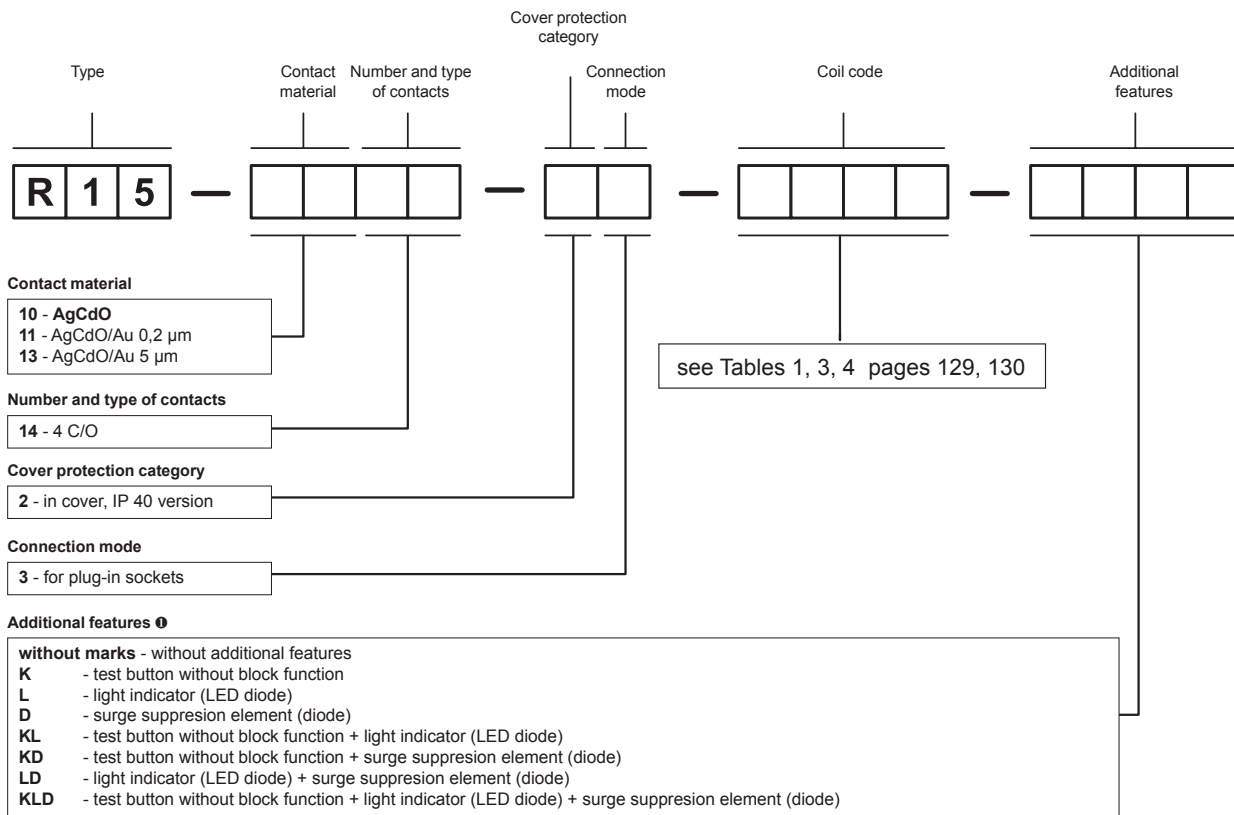

ⓘ D, KD, LD, KLD - only for DC coils

Note: for R15 4 C/O relays 50/60 Hz coils are not offered, show coil according with Table 3 or 4, pages 129, 130.

Example of ordering code:

R15-1014-23-3230-K relay **R15**, contact material AgCdO, with four changeover contacts, in cover IP 40, for plug-in sockets, voltage version 230 V AC 50 Hz, with test button without block function