

SONY

CXA1214P

SECAM Color Decoder

T-77-07-09

Description

The CXA1214P is a color signal processing IC for SECAM color television system. The IC has an ID determination circuit as well as the video processing circuits required for processing of color signals.

Features

- Combined use of the CXA1214P and CXA1213S makes it possible to configure a system compatible with all three systems, PAL, SECAM and NTSC.
- Has a self-contained automatic ID determination circuit.

Applications

- Color television
- SECAM color decoder

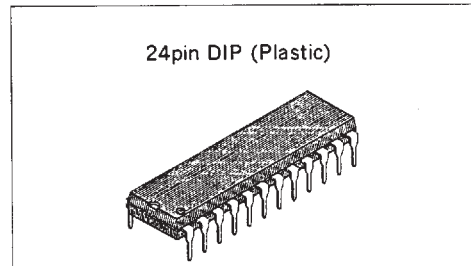

Structure

Bipolar silicon monolithic IC

Block Diagram

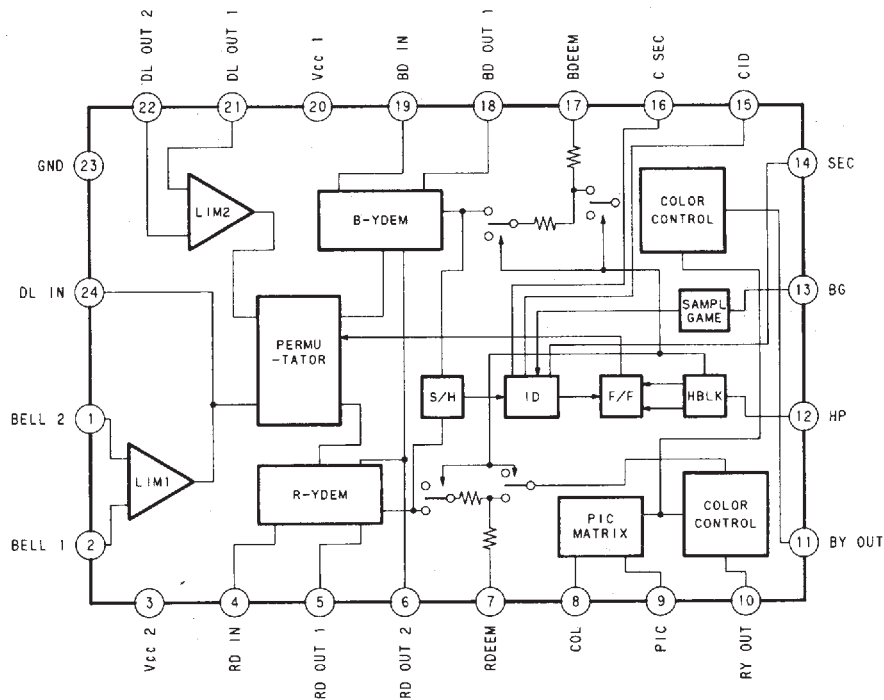

Pin Configuration

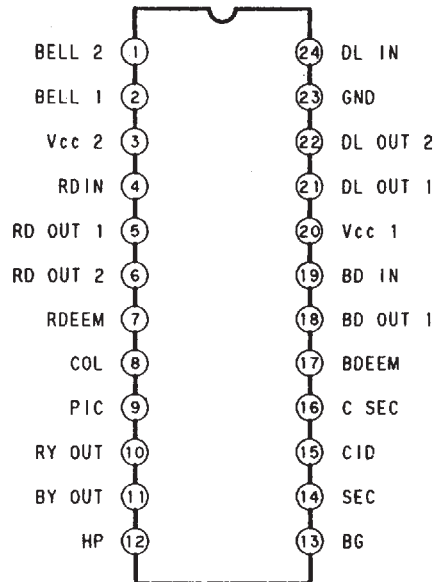

Operating Condition

• Supply voltage	V_{CC}	8.5 to 9.5	V
------------------	----------	------------	---

Absolute Maximum Ratings($T_a=25^\circ\text{C}$)

• Supply voltage	V_{CC1} V_{CC2}	7	V
• Operating temperature	T_{opr}	-20 to +75	$^\circ\text{C}$
• Storage temperature	T_{stg}	-55 to +125	$^\circ\text{C}$
• Allowable power dissipation	P_D	1.3	W

SONY®

CXA1214P

T-77-07-09

Pin Description

Pin No.	Symbol	Pin Voltage	Equivalent circuit	Description
1	BELL2	2.5V		Chrominance signal bias pin.
2	BELL1	2.5V		SECAM Chrominance signal input pin.
3	V _{CC2}	5V		Stabilized power supply decoupling pin. Connected to Pin 20, it allows supply of current (15mA standard) from outside.
4	RDIN	4.9V		Use this pin to connect the R-Y discriminator.
5	RDOUT1	1.7V		The FM demodulator input pin.

SONY®

T-77-07-09

CXA1214P

Pin No.	Symbol	Pin Voltage	Equivalent circuit	Description
6	RDOUT2	1.7V		FM demodulator bias pin.
7	RDEEM	2.5V		Use this pin to connect the de-emphasis capacitor.
8	COL	—		Color control pin.
9	PIC	—		Picture control pin.
10	RYOUT	2.5V		R-Y signal output pin.

SONY®

CXA1214P

T-77-07-09

Pin No.	Symbol	Pin Voltage	Equivalent circuit	Description
11	BYOUT	2.5V		B-Y signal output pin.
12	HP	2.5V		Flyback pulse input pin. Input positive 3Vp-p flyback pulse via a capacitor.
13	BG	—		Burst gate pulse input pin.
14	SEC	—		SECAM/SECAM output pin. Forced grounding of this pin creates the forced SECAM mode.
15	CID	—		Use this pin to connect the ID sample hold capacitor.

SONY®

CXA1214P

T-77-07-09

Pin No.	Symbol	Pin Voltage	Equivalent circuit	Description
16	CSEC	—		Time constant pin for identification of SECAM.
17	BDEEM	2.5V		Use this pin to connect the de-emphasis capacitor.
18	BDOUT1	1.7V		The FM demodulator input pin.
19	BDIN	4.9V		Use this pin to connect the B-Y discriminator.
20	V _{CC1}	5V		Connected to Pin 3, this pin allows supply of current (15mA Typ.) from outside.
21	DLOUT1	2.5V		Use this pin to input 1H delayed signal.

SONY

CXA1214P

T-77-07-09

Pin No.	Symbol	Pin Voltage	Equivalent circuit	Description
22	DLOUT2	2.5V		Delay line bias pin.
23	GND	0V		GND pin.
24	DLIN	2.5V		Delay line bias pin.

Electrical Characteristics



$T_a = 25^\circ\text{C}$, $V_{CC} = 9\text{V}$, Refer to Electrical Characteristics Test Circuit.

No.	Item	Symbol	SW condition	Bias condition	Condition	Min.	Typ.	Max.	Unit
1	Regulator voltage 1 $V_{CC} = 8$	V_{CC1}	—	1	Voltage at Pin 3 tested.	4.65	5.0	5.35	V
2	Regulator voltage 2 $V_{CC} = 9\text{V}$	V_{CC2}	—	2	Voltage at Pin 3 tested.	4.65	5.0	5.35	V
3	Regulator voltage difference 1	VD12	—	—	Difference between measurements of test No. 1 and 2.	—	—	30	mV
4	DEM difference R-Y	RDE	SW1 : OFF SW2 : OFF SW3 : OFF		Input signal : SG1, SG2 Difference in output DC level at Pin 10. 	-20	0	+20	mV
5	DEM difference B-Y	BDE	↓	↓	Input signal : SG1, SG2 Difference in output DC level at Pin 11.	-20	0	+20	mV
6	Output amplitude 1 R-Y	VR1	↓	↓	Input signal : SG3 p-p value of output at Pin 10 tested. 	0.73	0.899	1.14	Vp-p

SONY®

CXA1214P

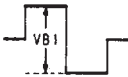
T-77-07-09

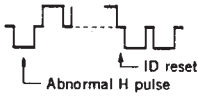
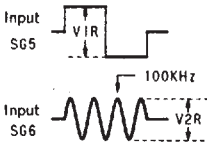
No.	Item	Symbol	SW condition	Bias condition	Condition	Min.	Typ.	Max.	Unit
7	Output amplitude 1 B-Y	VB1	↓	↓	Input signal : SG3 p-p value of output at Pin 11 tested. 	0.90	1.11	1.39	V _{p-p}
8	Output amplitude ratio R-Y/B-Y	VRB	—	—	Output amplitude ratio of above-mentioned Pins 6 and 7. $VRB = \frac{VR1}{VB1}$	0.75	0.813	0.87	
9	HBLK noise R-Y	VNR	↓	2	Input signal : SG1 Noise in BLK section of output at Pin 11 tested. 	—	—	10	mV _{rms}
10	HBLK noise B-Y	VNB	↓	↓	Input signal : SG1 Noise in BLK section of output at Pin 10 tested. 	—	—	10	mV _{rms}
11	ID reset R-Y	RID	↓	↓	Time from when abnormal pulse is forced into input signal (SG4HP) to when normal output is restored at Pin 11. 	0.15	0.303	0.43	mS _{ec}
12	ID reset B-Y	BID	↓	↓	Time from when abnormal pulse is forced into input signal (SG4HP) to when normal output is restored at Pin 10.	0.15	0.291	0.43	mS _{ec}
13	Deem characteristic R-Y 100kHz	DER2	SW1 : OFF SW2 : OFF SW3 : OFF	2	Input signal : SG5, SG6 Output level at Pin 11 tested.  $DER2 = 20 \log \frac{V_{2R}}{V_{1R}}$ (dB)	-2.71	-1.71	-0.70	dB

SONY

CXA1214P

T-77-07-09

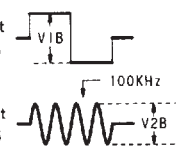
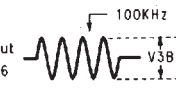
No.	Item	Symbol	SW condition	Bias condition	Condition	Min.	Typ.	Max.	Unit
14	Deem characteristic R-Y 50kHz	DER3	SW1 : ON SW2 : OFF SW3 : ON	↓	Input signal : SG5, SG6 Difference in output level at Pin 11 tested.  $DER3 = 20 \log \frac{V_{3R}}{V_{1R}} \text{ (dB)}$	-7.73	-6.73	-5.73	dB
15	Deem characteristic B-Y 100kHz	DEB2	SW1 : OFF SW2 : OFF SW3 : OFF	↓	Input signal : SG5, SG6 Difference in output level at Pin 10 tested.  $DEB2 = 20 \log \frac{V_{2B}}{V_{1B}} \text{ (dB)}$	-3.19	-2.19	-1.19	dB
16	Deem characteristic B-Y 500kHz	DEB3	SW1 : ON SW2 : OFF SW3 : ON	↓	Input signal : SG5, SG6 Difference in output level at Pin 10 tested.  $DEB3 = 20 \log \frac{V_{3B}}{V_{1B}} \text{ (dB)}$	-6.71	-5.71	-4.71	dB
17	Killer Point	KIL	SW1 : OFF SW2 : OFF SW3 : OFF	↓	Input signal : SG3 Input signal reduced to find the point where the Killer is caused to be ON. (Voltage at Pin 14...0.2V or less).	-65	-50	-35	dB
18	Killer drive	KILR	SW1 : OFF SW2 : OFF SW3 : OFF	↓	Input signal : SG3 Voltage at Pin 14 tested when input signal is reduced to 65dB.	—	—	1	V
19	Regulator voltage difference 2	VD23	—	3	Difference from testing 2 tested in voltage at Pin 3.	—	—	40	mV

Bias Condition Table

Power supply No.	E ₁	E ₂	E ₃
1	8V	3V	3
2	9	3	3
3	10	3	3

SONY

T-77-07-09

CXA1214P

Electrical Characteristics Test Circuit

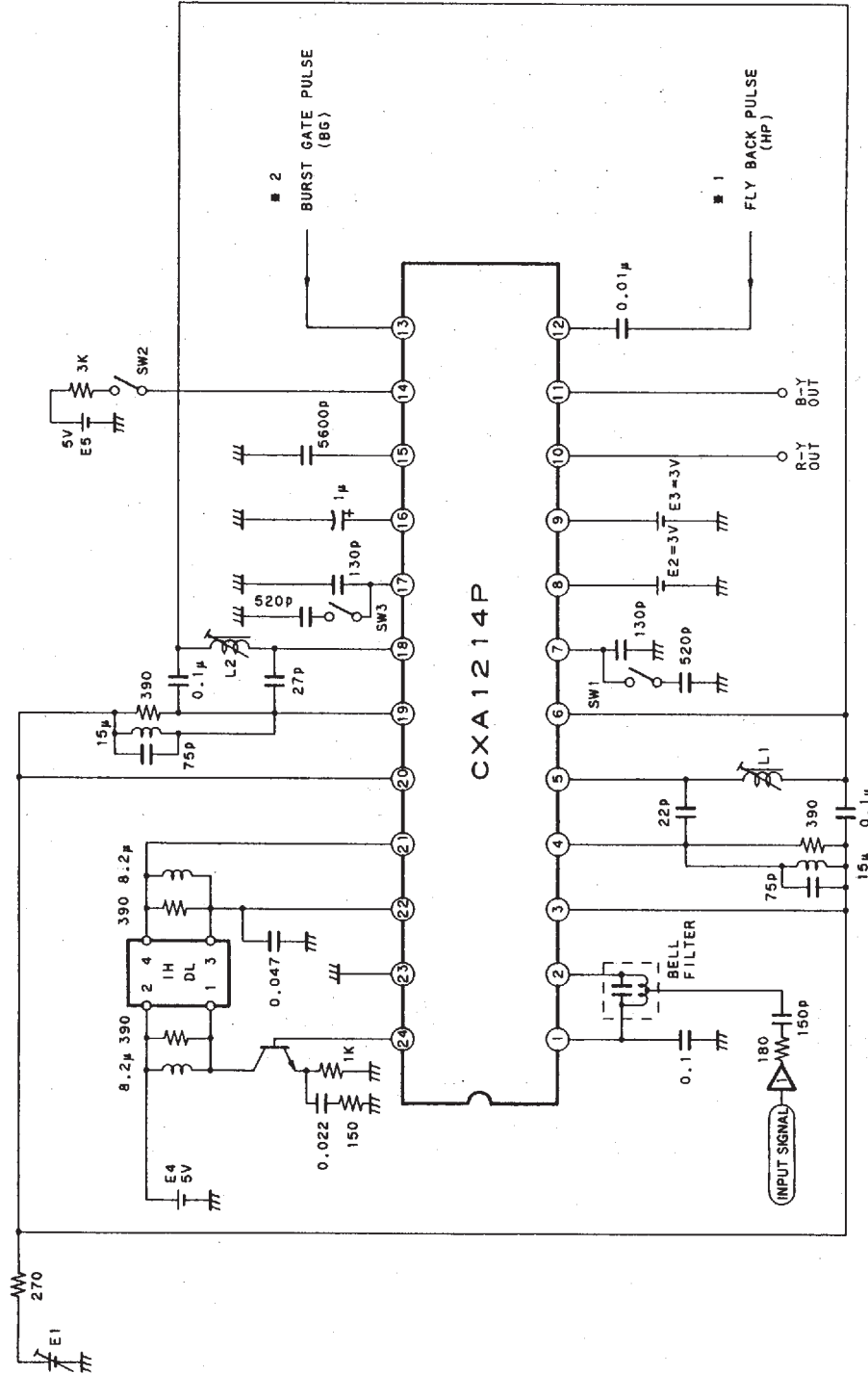

SONY®

T-77-07-09

CXA1214P

Input signal

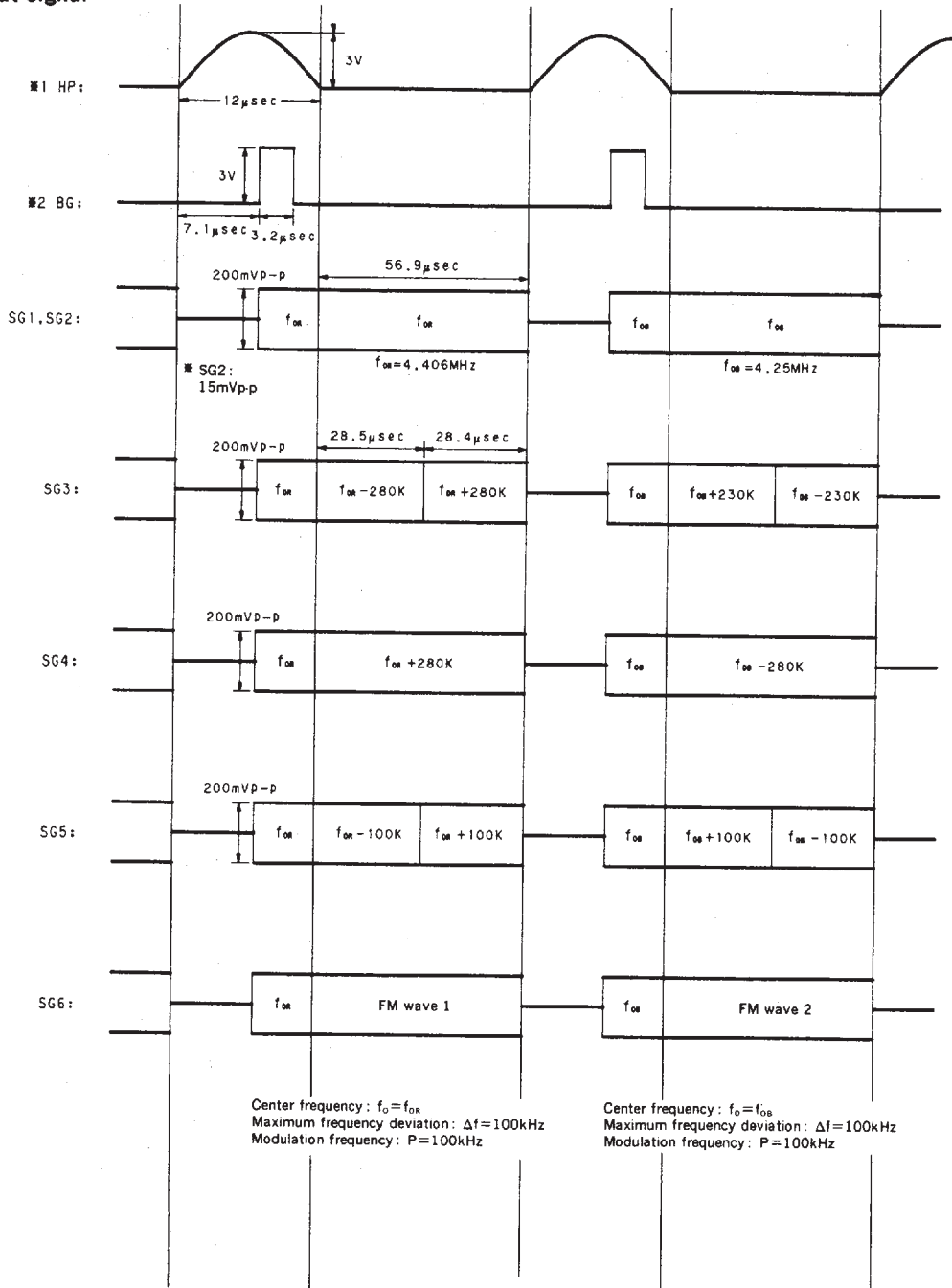

SONY®

CXA1214P

T-77-07-09

Operation

SECAM color signal is input from Pin 2 via the bell filter. The signal is passed through the limiter from which it is directly routed to the permutator and is also output to Pin 24.

The signal output from Pin 24 passes through the 1H delay line and is re-input from Pin 21 and it is sent through the limiter to the permutator.

In response to a switching pulse from the determination system, the permutator sends either the signal directly input from the bell filter or the signal input via the 1H delay line to the R-Y or B-Y FM detector.

The color signals passed through the FM detectors are output through the respective de-emphasis circuits and color control circuits to Pins 10 (R-Y output) and 11 (B-Y output).

The determination system monitors the outputs from the FM detectors to check whether the permutator is correctly switching the signals, and provides controls to make sure that the permutator correctly switches the signals. When no SECAM signal is input, the forced killer is activated to block output of R-Y and B-Y signals. In addition, the output at Pin 14 is caused to be "Low".

Application Circuit

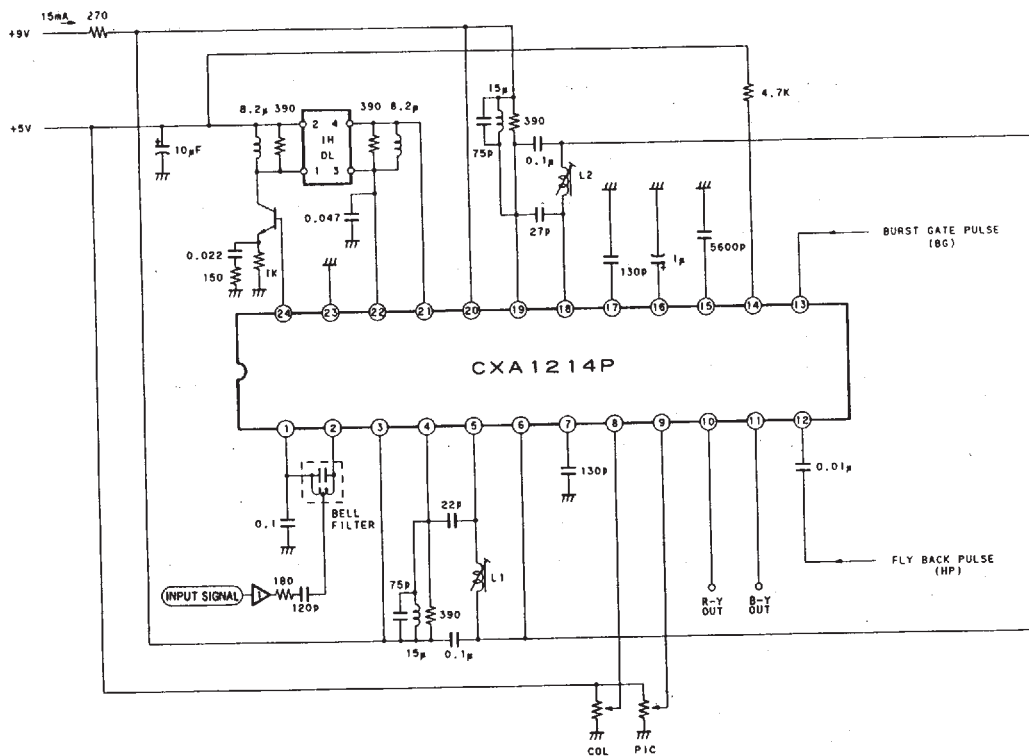

SONY

CXA1214P

T-77-07-09

Adjustment procedure

Input SECAM color bar signal to Pin 2 via the bell filter. Adjust coil L1 so that the video section black level and BLK level will be in alignment in the output at Pin 10.

Similarly, adjust coil L2 so that the black level and BLK level will be in alignment in the output at Pin 11.

Example of characteristics

Color Control Characteristics (When color bar is input)

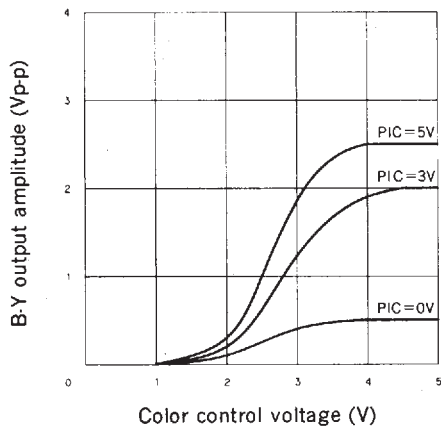

SONY®

CXA1214P

T-77-07-09

Package Outline Unit: mm

24pin DIP (Plastic) 400mil 2.0g

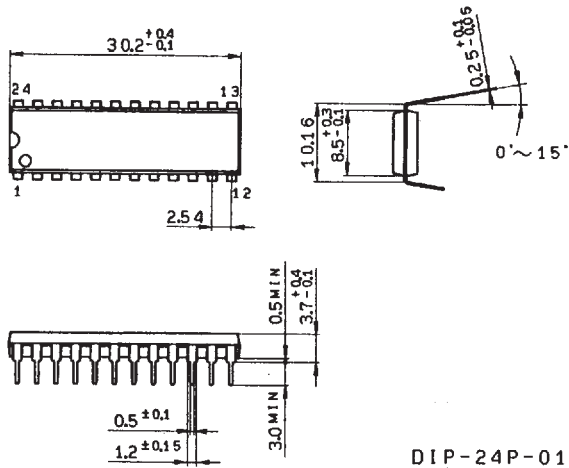

DIP-24P-01